

SEGATM CD

SEGATM

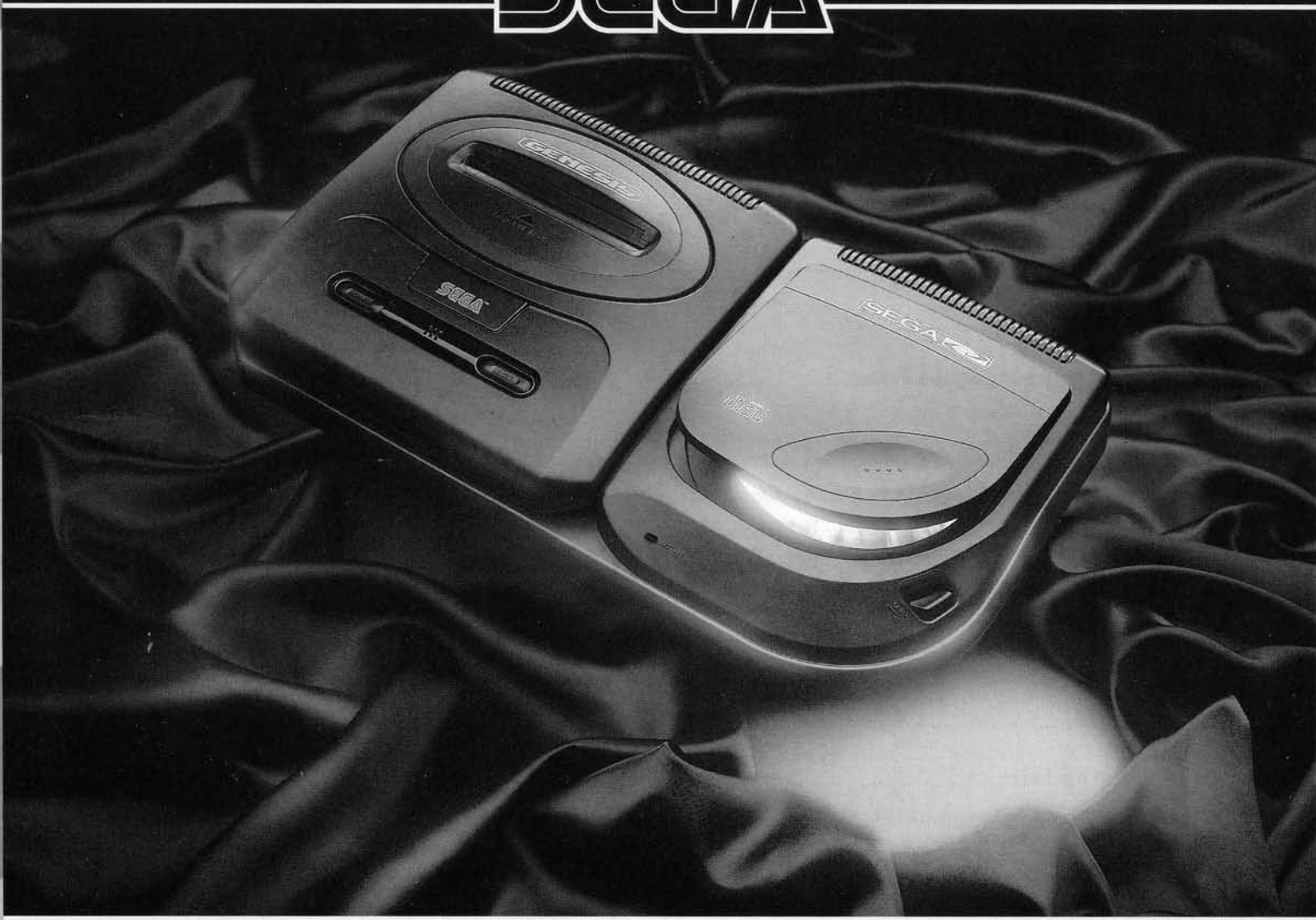

USER'S GUIDE

CONTENTS

Introduction	2	Playing Audio CDs	15
Unpacking Your Sega CD	3	Playing Audio Plus Graphics Discs (CD+Gs)	16
To Connect Your System to the original Genesis Model	4	Playing Sega CD Video Games (CD-Roms)	16
To Connect Your System to the new Genesis Model	6	Ending a Session	17
To Connect Stereo Sound: original Genesis Model	8	Using the Sega CD Features	17
Headphones and Mini Speakers	8	The Control Panel	17
Home Stereo Systems and Portable Cassette Players	9	Control Panel Display	17
Stereo TV or Stereo VCR	10	Control Panel Buttons	18
To Connect Stereo Sound: New Genesis Model	11	The Program Menu	19
Home Stereo Systems and Portable Cassette Players	11	The Memory Menu	22
Stereo TV or Stereo VCR	11	Maintaining Your Sega CD	23
Operating the Sega CD	12	Troubleshooting	23
Starting Up for the First Time	13	Sega CD Hardware Information	24
Starting Up with a Disc in the Drive	13	Note: The Sega CD is for home use only, and not for commercial use. The Sega CD is for use in North America (NTSC standard) only.	
Reading the Indicator LED	14	Important: Please read page 29 before you connect your Sega CD.	
Using the Control Pad	14		
Operating Without Video (Quick Buttons)	15		

GAME PLAY ASSISTANCE AND INFORMATION

For expert game play assistance or information on other great Sega products, call the Sega experts at: **1-415-591-PLAY**.

IF YOU NEED HELP

If you have problems operating your Sega CD, first check the Troubleshooting section on page 23. If the problem persists, or if you can't resolve it, call the Sega Consumer Service Department at **1-800-USA-SEGA**.

EPILEPSY WARNING

WARNING: READ BEFORE USING YOUR SEGA VIDEO GAME SYSTEM.

A very small percentage of individuals may experience epileptic seizures when exposed to certain light patterns or flashing lights. Exposure to certain patterns or backgrounds on a television screen or while playing video games may induce an epileptic seizure in these individuals. Certain conditions may induce undetected epileptic symptoms even in persons who have no history of prior seizures or epilepsy. If you, or anyone in your family, has an epileptic condition, consult your physician prior to playing. If you experience any of the following symptoms while playing a video game — dizziness, altered vision, eye or muscle twitches, loss of awareness, disorientation, any involuntary movement, or convulsions — **IMMEDIATELY** discontinue use and consult your physician before resuming play.

WARNING TO OWNERS OF PROJECTION TELEVISIONS

Still pictures or images may cause permanent picture-tube damage or mark the phosphor of the CRT. Avoid repeated or extended use of CD-based video displays on large-screen projection televisions. Consult your owner's manual before playing video games on your projection television.

INTRODUCTION

The Sega CD is a multimedia entertainment system that lets you enjoy outstanding audio, video and games on compact disc. It connects to your Sega Genesis™ to play sharp, clean sound and brilliant color graphics with up to 64 colors from a palette of 512 colors on your TV. You can even enjoy rich stereo sound by using a portable music player or stereo speakers.

Take advantage of the Sega CD's wide range of features. For example, you can choose which tracks you'll play, set repeat marks to replay favorite sections again and again. Shuffle the tracks, program their order and set pauses so you get exactly what you want.

The Sega CD lets you save CD games from any software with a Save feature. Later, you can pick up your current game right where you left off. The best part of your Sega CD is that you can still play all your Sega Genesis cartridges while building an exciting library of all-new multimedia Sega CD games!

Connecting your Sega CD takes only a few minutes. Then use your Genesis control pad to operate the system, and get ready for a lifetime of fantastic compact disc entertainment.

The Sega CD is compatible with these disc types:

Audio Music (CD)

Audio + Graphics (CD+G)

Sega CD Games (CD-Rom)

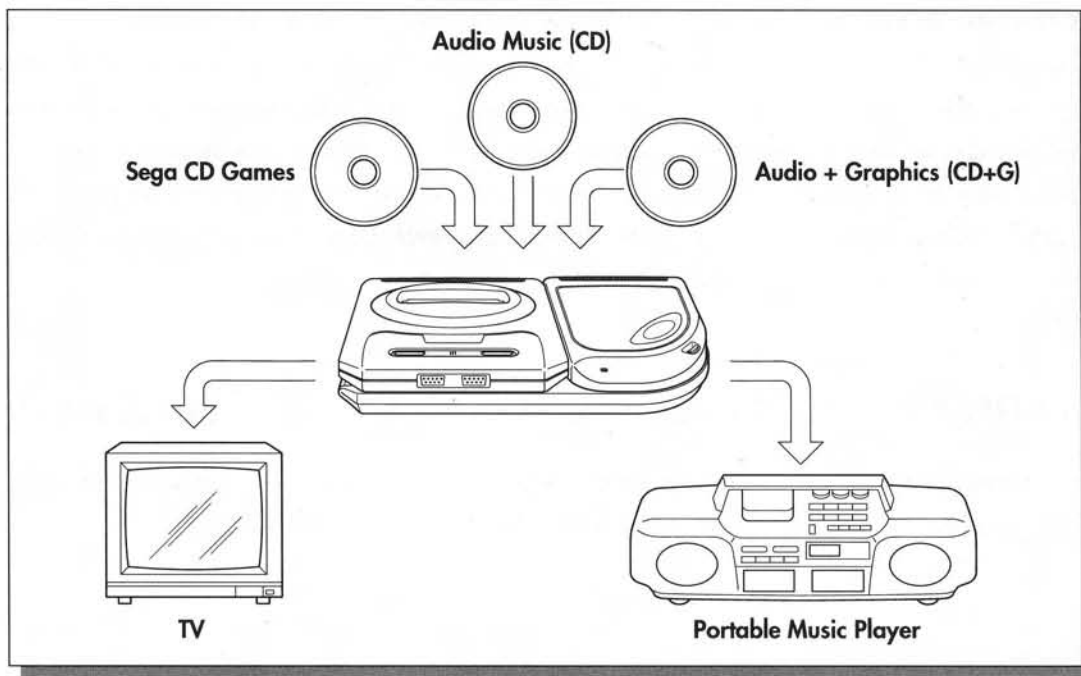

UNPACKING YOUR SEGA CD

Use the checklist to make sure you've received all the components of your Sega CD system. If anything is missing, please call the Sega Consumer Service Department at **1-800-USA-SEGA**.

Unpacking Checklist

- Sega CD console
- Steel joining plate and screw
- Small joining plate and 2 screws
(for use with the original Genesis model)
- Extension spacer
(for use with the original Genesis model)
- 2 small connector plates
- AC adapter
- Sound mixing cable
(for use with the original Genesis model)
- *Sega CD User's Manual* (this book)
- Consumer reply card

Before connecting your Sega CD, look at the console to become familiar with its parts.

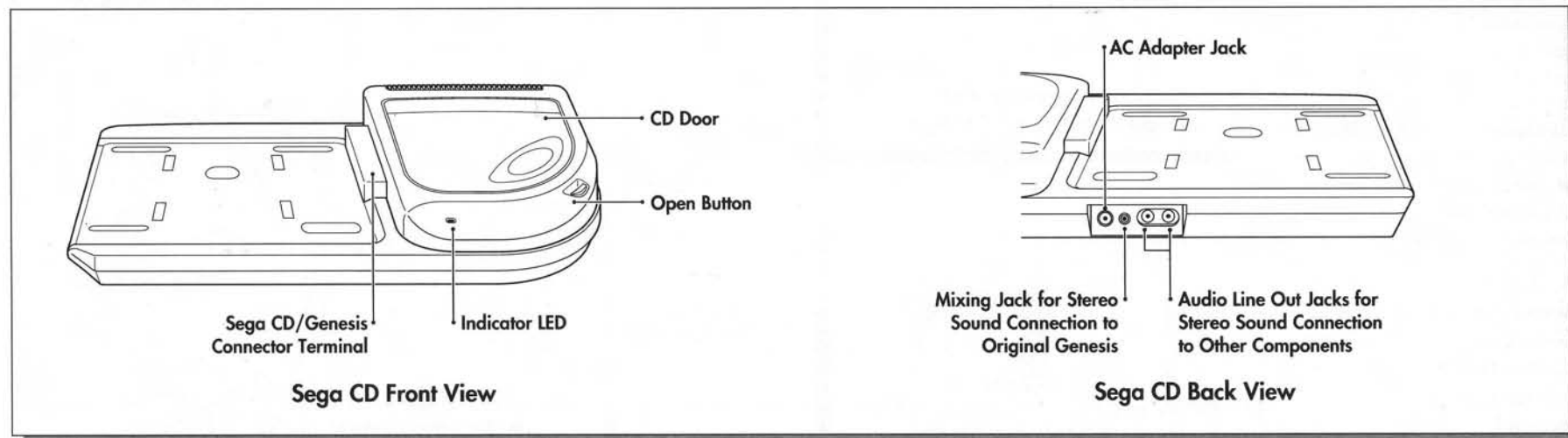

Please read the setup instructions in this manual thoroughly before installing your system. Then read the operating instructions for information on using all of the features of the Sega CD. **Fill out and return the consumer reply card that came with your system to ensure warranty coverage.** Then keep this manual on hand for reference on Sega CD operation and troubleshooting.

TO CONNECT YOUR SYSTEM TO THE ORIGINAL GENESIS MODEL

Make sure your Genesis system is set up and operating properly before connecting your Sega CD. (Please see your *Sega Genesis Instruction Manual* for details.) Then follow these steps:

1. Unplug the Genesis from its AC adapter.

2. Locate the expansion slot panel on the right side of the Genesis. Remove the panel by pressing in on its bottom and taking the panel off the console. Remove the red plastic cover from the expansion slot connector.

Note: Look carefully at the "piano" contacts on the connector. Over time, some tarnish or corrosion may have accumulated. If the contacts appear to be tarnished, carefully clean **both sides** with a soft, non-abrasive art eraser or pencil eraser. Rub gently to prevent damage to the contacts.

3. Attach the flat connector plate to the bottom of the Genesis (this plate hooks into position over the vents). The L-shaped connector is not required.

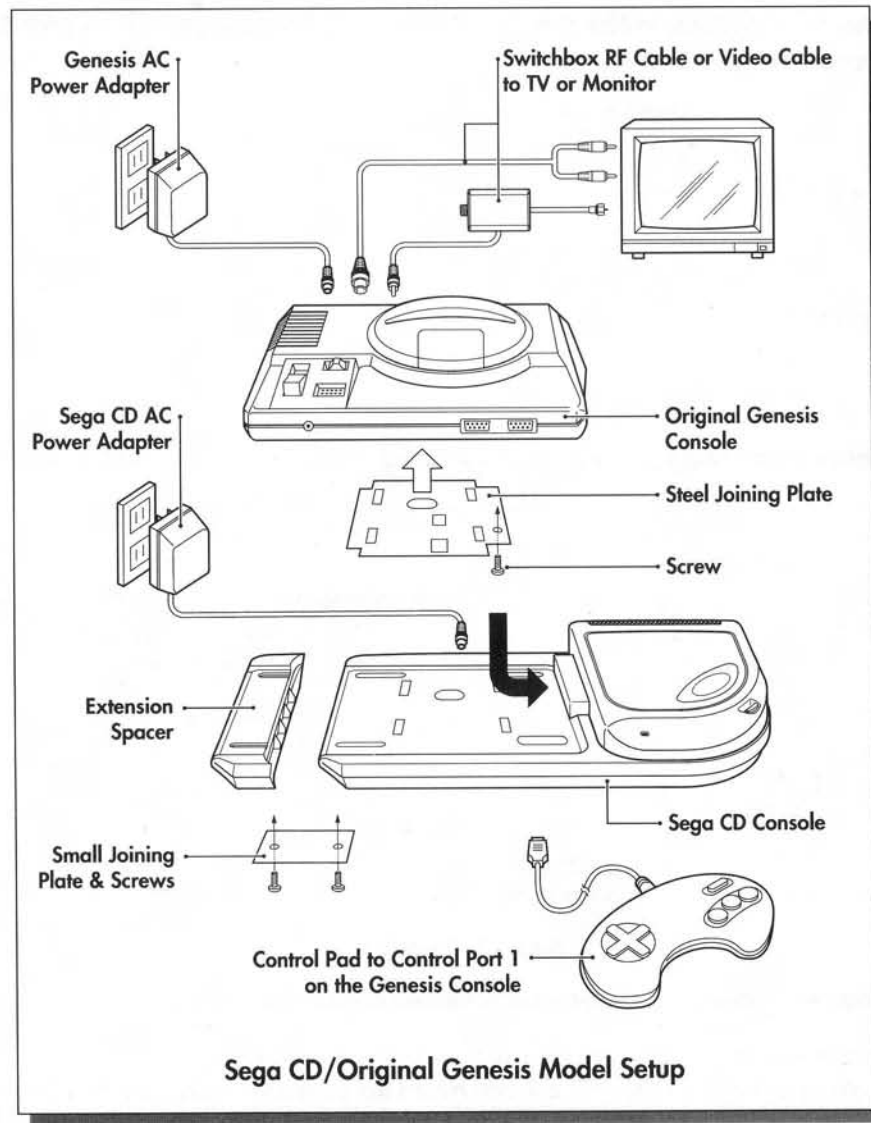
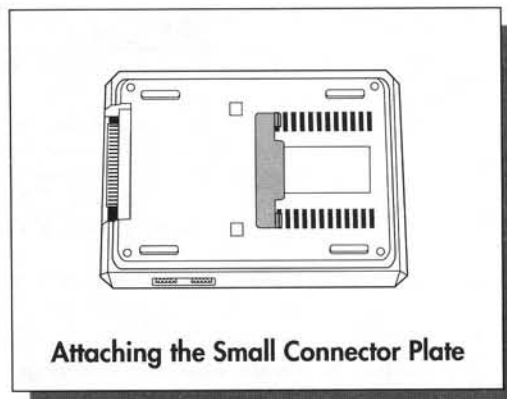
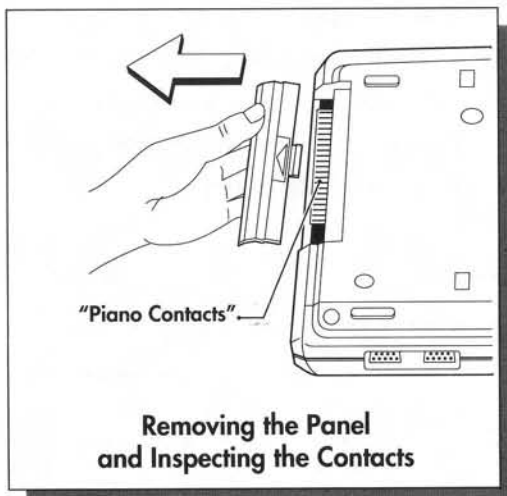

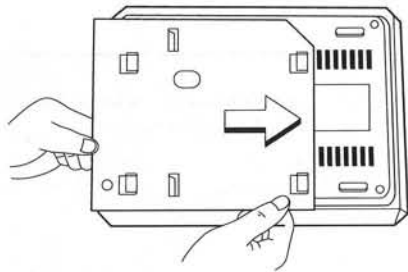

Positioning the Steel Joining Plate

4. Position the steel joining plate on the bottom of the Genesis console. Use a medium-size Phillips-head screwdriver to attach it with the screw. The joining plate anchors the Genesis neatly to the Sega CD allowing the connectors to fit properly into the connector terminal.

Note: It is vital to install the steel joining plate, which provides an RF shield between the Genesis and the Sega CD.

5. Slide the Genesis sideways, from left to right, into place on top of the Sega CD. Make sure the connector in the Genesis expansion slot fits snugly into the connector terminal on the Sega CD.

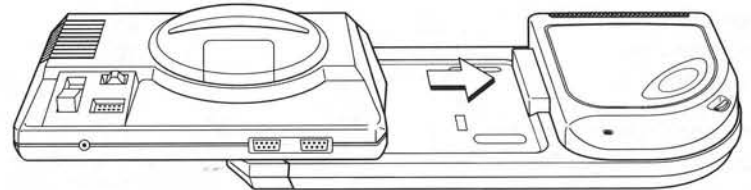

Sliding the Original Genesis Model onto the Sega CD

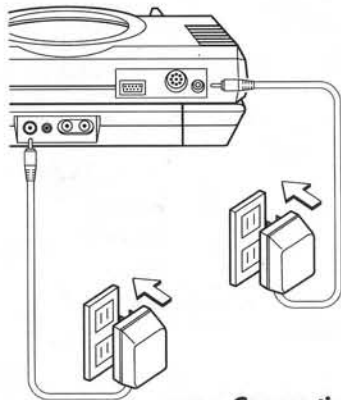

Connecting the AC Adapters

6. Make sure the Genesis power switch is turned off. Then plug in its AC adapter.
7. Plug the Sega CD's AC adapter cable into its jack on the back of the Sega CD console. Then plug the adapter directly into an electrical outlet. (Do not use an extension cord.)

Note: Do not switch the AC adapters. Use the Genesis AC adapter **only** with the Genesis, and the Sega CD AC adapter **only** with the Sega CD.

TO CONNECT YOUR SYSTEM TO THE NEW GENESIS MODEL

Make sure your Genesis system is set up and operating properly before connecting your Sega CD. (Please see your *Sega Genesis Instruction Manual* for details.) Then follow these steps:

1. Unplug the Genesis from its AC adapter.

2. Locate the expansion slot panel on the right side of the Genesis. Remove the panel by pressing in on its bottom and taking the panel off the console. Remove the red plastic cover from the expansion slot connector.

Note: Look carefully at the "piano" contacts on the connector. Over time, some tarnish or corrosion may have accumulated. If the contacts appear to be tarnished, carefully clean **both sides** with a soft, non-abrasive art eraser or pencil eraser. Rub gently to prevent damage to the contacts.

3. Attach the flat connector plate to the bottom of the Genesis (this plate hooks into position over the vents). Then attach the L-shaped connector plate to the expansion slot. Take care not to damage the expansion slot connector.

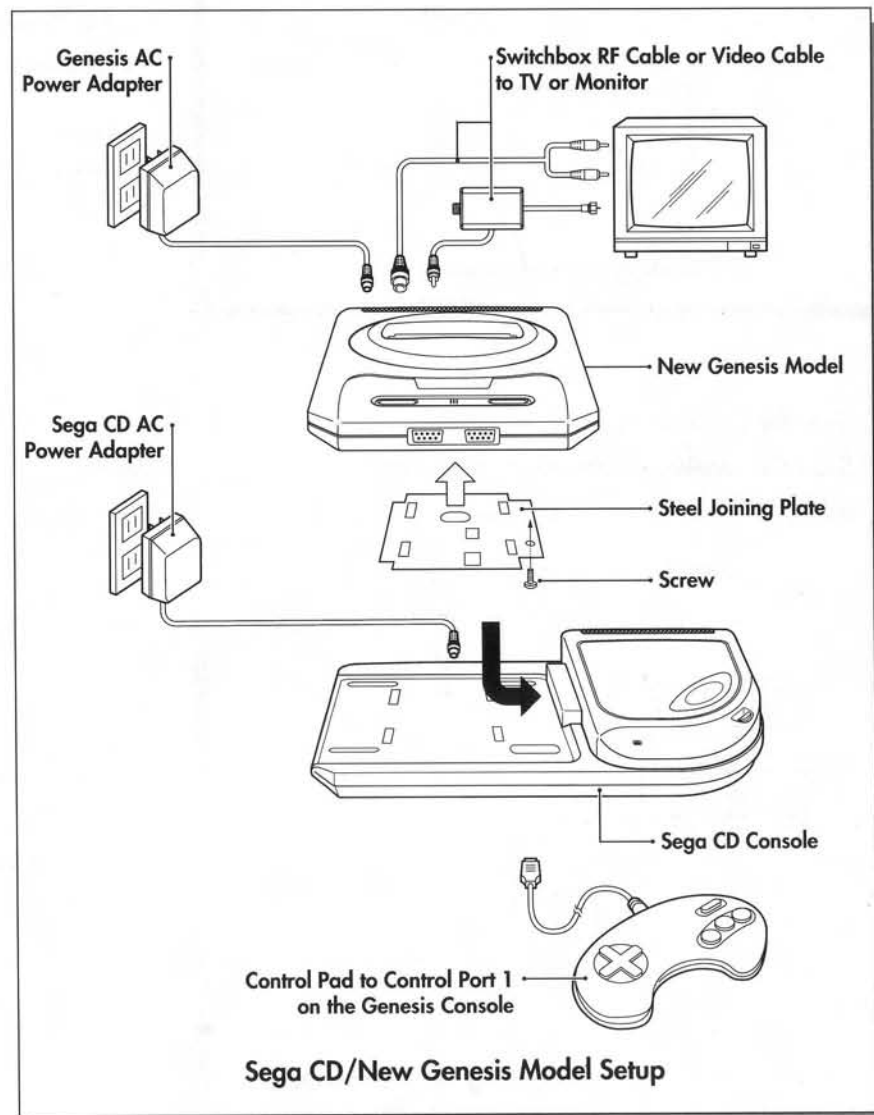
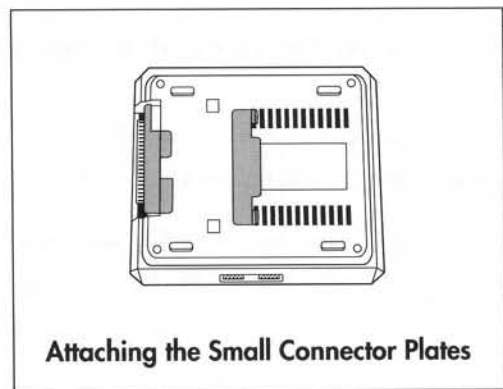
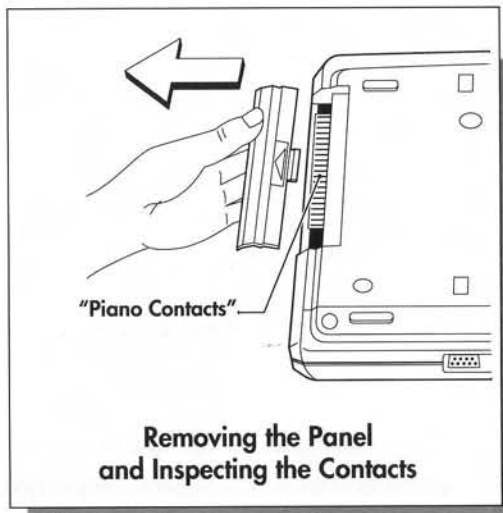

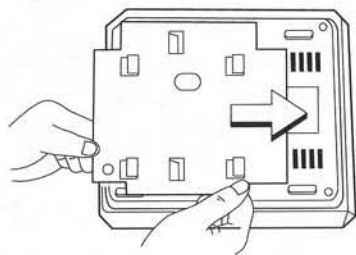

Positioning the Steel Joining Plate

- Slide the Genesis sideways, from left to right, into place on top of the Sega CD. Make sure the connector in the Genesis expansion slot fits snugly into the connector terminal on the Sega CD.

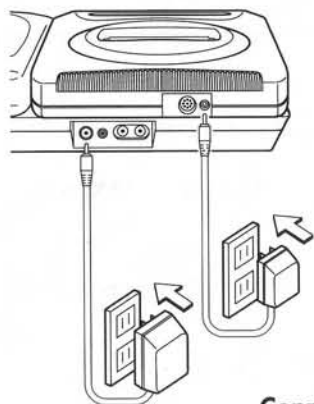

Connecting the AC Adapters

- Position the steel joining plate on the bottom of the Genesis console. Use a medium-size Phillips-head screwdriver to attach it in place with the screw. The joining plate anchors the Genesis neatly to the Sega CD, allowing the connectors to fit properly into the connector terminal.

Note: It is vital to install the steel joining plate, which provides an RF shield between the Genesis and the Sega CD.

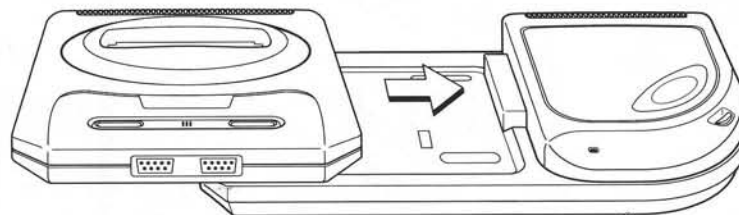

Sliding the New Genesis Model onto the Sega CD

- Make sure the Genesis power switch is turned off. Then plug in its AC adapter.
- Plug the Sega CD's AC adapter cable into its jack on the back of the Sega CD console. Then plug the adapter directly into an electrical outlet. (Do not use an extension cord.)

Note: Do not switch the AC adapters. Use the Genesis AC adapter **only** with the Genesis, and the Sega CD AC adapter **only** with the Sega CD.

TO CONNECT STEREO SOUND: ORIGINAL GENESIS MODEL

Attaching the Sega CD to a stereo system will dramatically increase the sound quality of audio discs and Sega CD games. It will also enhance the sound performance of Genesis cartridge games. This section shows you how to add stereo sound to enrich your enjoyment of the Sega CD system.

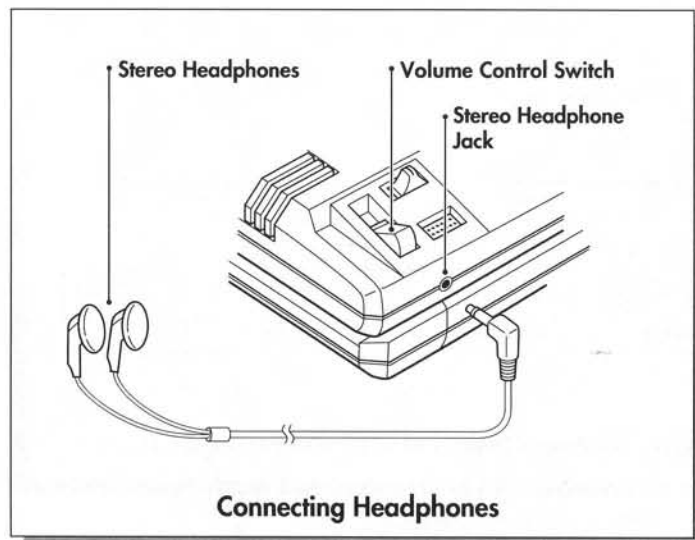

HEADPHONES AND MINI SPEAKERS

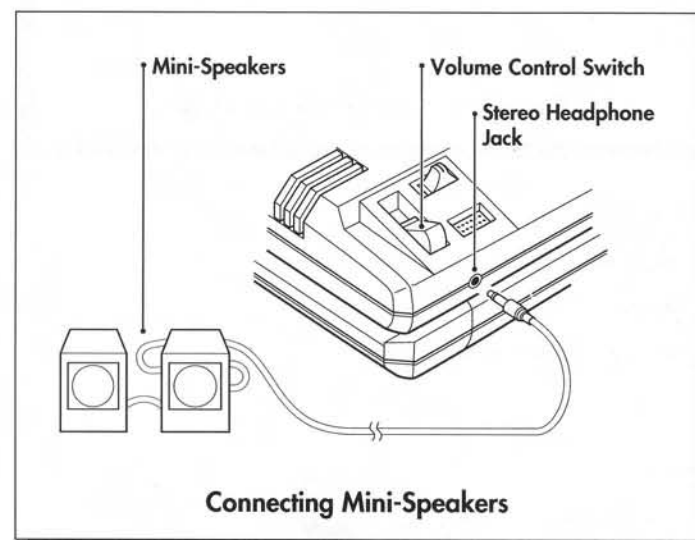

1. Plug stereo headphones or mini-speakers with internal amplifiers into the Stereo Headphone jack on the front of the original Genesis model.
2. When using headphones, adjust the volume with the volume control switch on the top of the Genesis. Normal volume is about 7 or 8. Be sure to use only stereo headphones. Using an earphone (monaural) or any similar device may damage it.
3. When using mini-speakers, please see their instruction manual for details on their operation. The volume control switch on top of the Genesis console may control their volume.

HOME STEREO SYSTEMS AND PORTABLE CASSETTE PLAYERS

1. Connect the left and right plugs from one end of a standard 2-pin RCA-type cable to the two Audio "Line Out" jacks on the back of the Sega CD.
2. Connect the left and right plugs from the other end of the cable to the left and right Audio "Line In" jacks on your stereo receiver or cassette player.
3. Connect one end of the sound mixing cable, supplied with your Sega CD, to the Mixing jack on the back of the Sega CD.
4. Connect the other end of the sound mixing cable to the Stereo Headphone jack on the front of the Genesis.
5. Adjust the volume with the volume control switch on the top of the Genesis console. Normal volume is about 7 or 8.

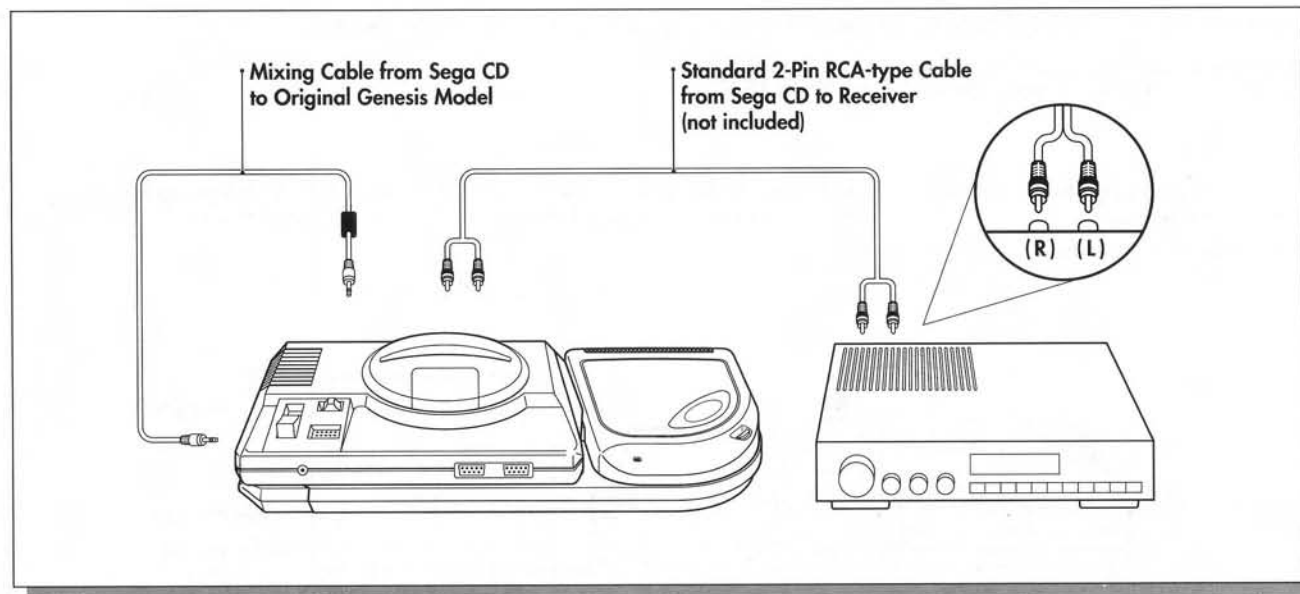

STEREO TV OR STEREO VCR

1. Connect the single-plug end of the Sega Audio/Video cable to the Audio/Video jack on the back of your Genesis.
Note: You can buy Sega's 8-pin Audio/Video cable at your Sega dealer or by calling **1-800-USA-SEGA**.
2. Only connect the yellow (video) plug from the two-plug end of the Sega Audio/Video cable to the Video Input jack on your stereo TV or stereo VCR.
Let the white (audio) plug hang loose.
3. Connect the left and right plugs from one end of a standard 2-pin RCA-type cable to the two Audio "Line Out" jacks on the back of the Sega CD.
Note: You can buy Sega's accessory RCA-type stereo cable at your Sega dealer or by calling **1-800-USA-SEGA**.
4. Connect the left and right plugs from the other end of the cable to the left and right Audio "Line In" jacks on your stereo TV or stereo VCR.
5. Connect one end of the sound mixing cable that came with your Sega CD to the Mixing jack on the back of the Sega CD.
6. Connect the other end of the sound mixing cable to the Stereo Headphone jack on the front of the Genesis.
7. Select the Audio/Video Input setting on your stereo TV or stereo VCR.

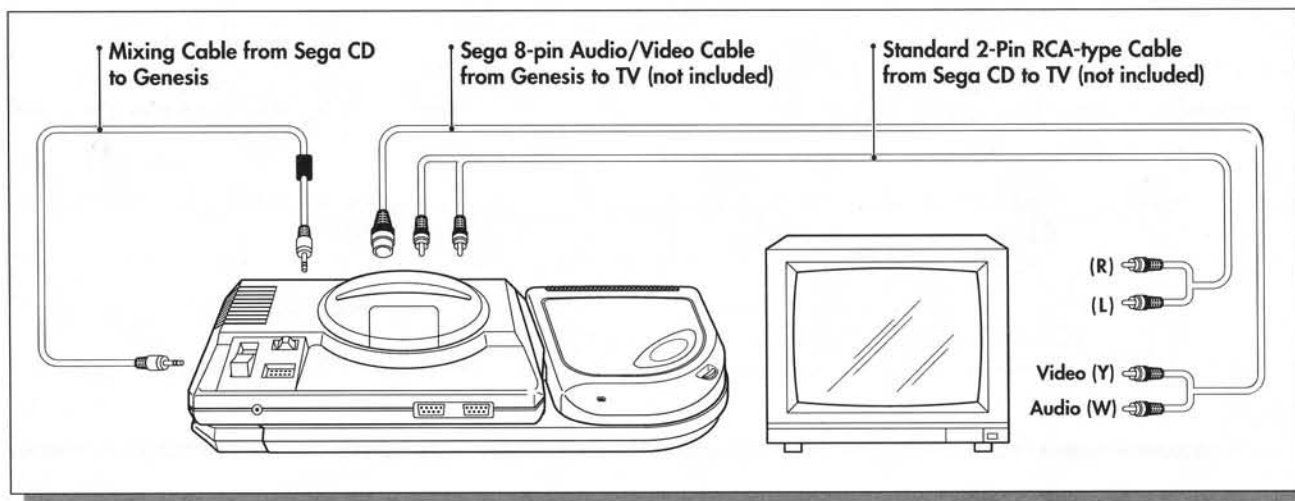

TO CONNECT STEREO SOUND: NEW GENESIS MODEL

HOME STEREO SYSTEMS AND PORTABLE CASSETTE PLAYERS

1. Connect the left and right plugs from one end of a standard 2-pin RCA-type cable to the two Audio "Line Out" jacks on the back of the Sega CD.
2. Connect the left and right plugs from the other end of the cable to the left and right Audio "Line In" jacks on your stereo receiver or cassette player.
3. Adjust the volume with the volume control switch on your stereo system or cassette player.

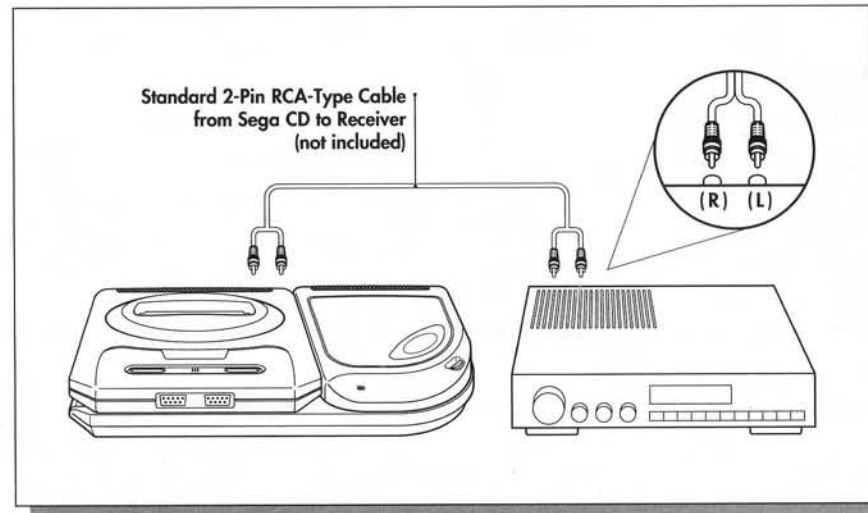

STEREO TV OR STEREO VCR

If your TV has Video and Stereo Audio Input jacks (Stereo TV), you can use the Sega **9-pin** stereo Audio/Video cable for improved graphics and stereo sound. No other connectors are necessary.

Note: You can buy Sega's 9-pin audio/video cable at your Sega dealer or by calling **1-800-USA-SEGA**.

1. Connect the single-plug end of the Sega **9-pin** stereo audio/video cable to the Audio/Video jack on the back of your new Genesis model.
2. Connect the **yellow** (video) plug on the three-plug end of the Sega stereo audio/video cable to the Video Input jack on your stereo TV or stereo VCR.
3. Connect the **white** plug to the left Audio Input jack, and connect the **red** plug to the right Audio Input jack on your stereo TV or stereo VCR.
4. Select the Audio/Video Input setting on your stereo TV or stereo VCR.

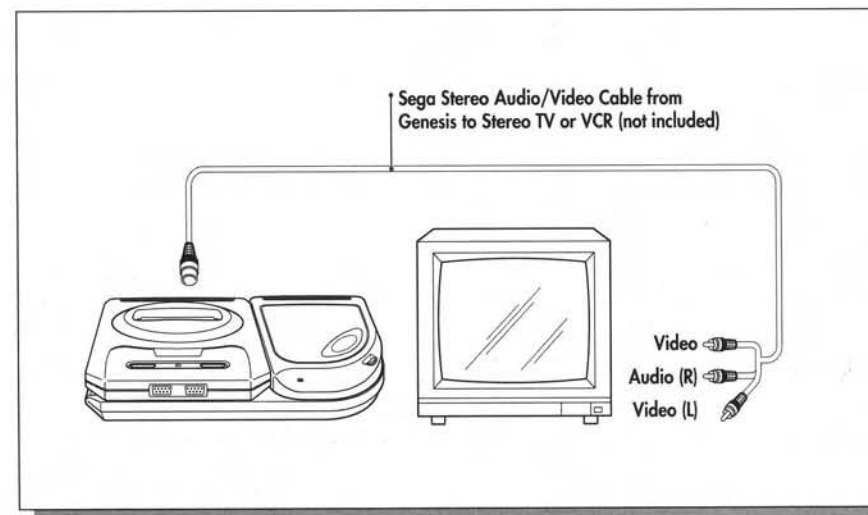

OPERATING THE SEGA CD

With your Sega CD connected, you can start up the system. First, please review this checklist:

Startup Checklist

1. Are the Sega CD and the Genesis console connected correctly to each other?
2. Is the Genesis connected correctly to the TV or monitor?
3. Are any additional stereo-sound components connected correctly to the system?
4. Are both the Sega CD and the Genesis connected to power by their correct AC adapters?
5. Is control pad 1 plugged into the Genesis console?
6. Is the Genesis cartridge slot empty? **(If a cartridge is inserted in the slot at startup, the Genesis system will default to cartridge play.)**

If you answered "Yes" to all six questions, you're ready to start.

STARTING UP FOR THE FIRST TIME

1. Turn on the TV, and then turn on the Genesis. The Sega CD logo appears.



2. Press the **Start** button or **Button A, B or C** on the control pad. The Sega CD Control Panel appears. The cursor on screen is pointing to the message "No Disc".



3. Press the **Open** button on the Sega CD console to open the CD door.

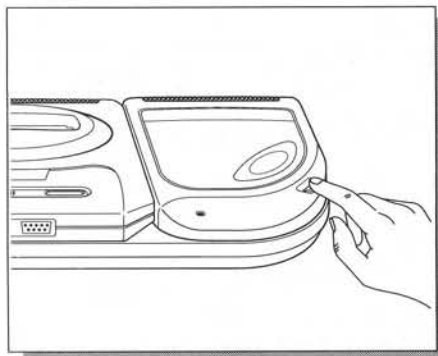

4. Place a disc in the tray, label side up.

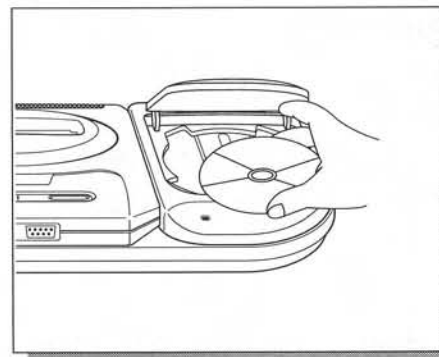

5. Close the CD door

Important: Never open the CD door when the disc is rotating. Doing so could damage your Sega CD system.

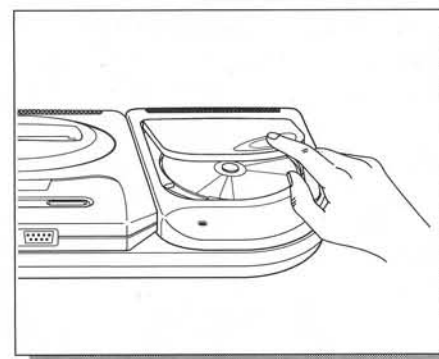

STARTING UP WITH A DISC IN THE DRIVE

If an audio CD or a CD+G is in the drive, the Sega CD logo appears when you turn on the Genesis.

If a Sega CD game is in the drive, the system detects the game when you turn on the Genesis and the game will start. Before the game starts, you can press **Button A, B or C** to bring up the Control Panel. Then, you can listen to and work with the game's music in the same way you use an audio CD.

READING THE INDICATOR LED

- Lights up when the Sega CD is playing a disc or reading game data.
- Flashes when there is no disc in the drive or when the CD door is open.
- Dims when the Sega CD is standing by. Remains unlit in Audio CD Playback and Pause modes.

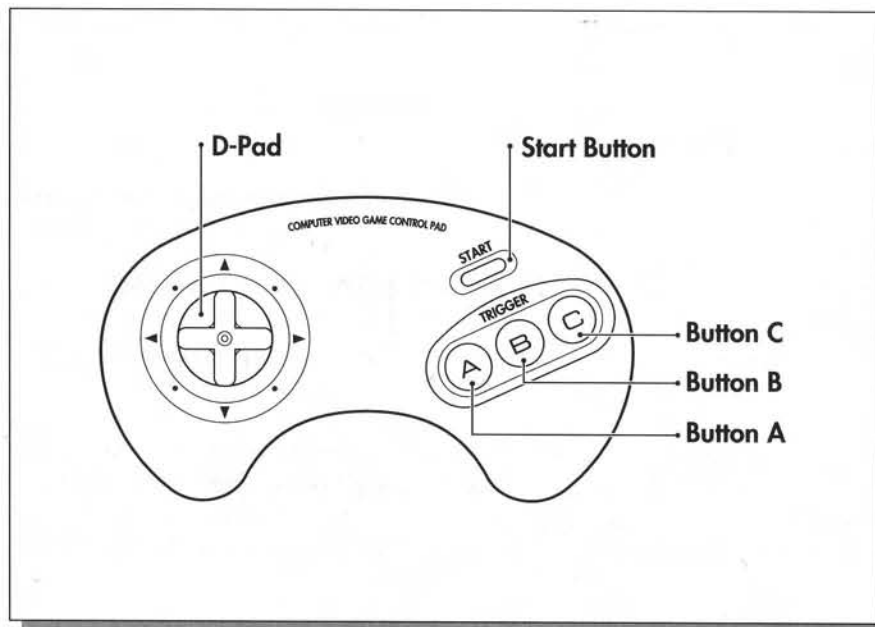
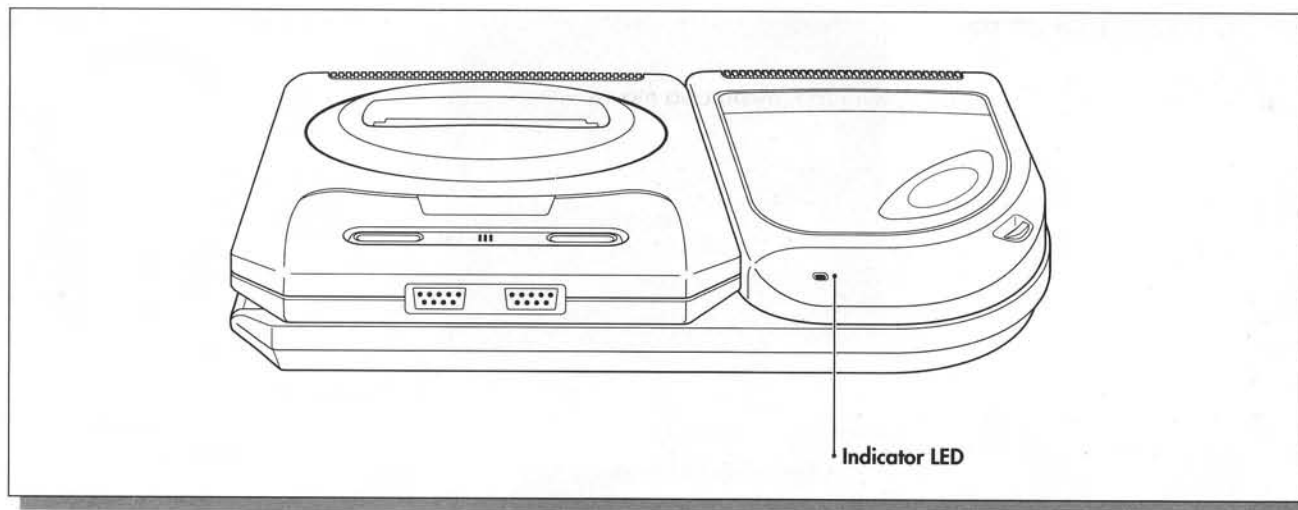

USING THE CONTROL PAD

You operate the Sega CD with Genesis control pad 1 (plugged into control port 1 on the Genesis console). This section lists the functions of each control pad button.

D-Pad

- Moves the cursor on the control panel.

Start Button

- Goes from the Sega CD logo to the Control Panel.
- When an audio CD or audio plus graphics disc (CD+G) is inserted but not playing, moves the cursor to the PLAY button from any other button on the Control Panel.
- If the system is stopped, closes the Program menu and moves the cursor to the PLAY button.
- If the system is playing, closes the Program menu and moves the cursor to the PAUSE button.

- If the system is stopped, closes the Set Prog. menu and moves the cursor to the PLAY button.
- If the system is playing, closes the Set Prog. menu and moves the cursor to the PAUSE button.
- When a Sega CD game disc is inserted and the Sega CD logo is on screen, starts the game.
- When a Sega CD game disc is inserted and the Control Panel is on screen, moves the cursor to the CD-ROM button.

Button A

- When any disc is inserted and the Sega CD logo is on screen, goes to the Control Panel.
- Executes the Control Panel option marked by the cursor.

Button B

- When any disc is inserted and the Sega CD logo is on screen, goes to the Control Panel.
- Executes the Control Panel option marked by the cursor.
- When the CD+G button is highlighted, hides the Control Panel or restores it to the screen.

Button C

- When any disc is inserted and the Sega CD logo is on screen, goes to the Control Panel.
- Executes the Control Panel option marked by the cursor.
- Returns the screen to the Sega CD logo.

OPERATING WITHOUT VIDEO (QUICK BUTTONS)

You don't have to turn on your TV to use the Sega CD, if it is connected to another stereo sound system. Instead, just turn on your Genesis and use these button controls:

- | | |
|-------------------------|--|
| Start + Button A | Play the CD. |
| Start + Button B | Stop. |
| Start + Button C | Play or pause the CD. |
| Start + D-Pad | Auto-search (left tracks backward; right tracks forward). |

Note: These button controls also work when playing a CD+G with the Control Panel hidden.

PLAYING AUDIO CDS

1. Place an audio CD in the disc tray and close the CD door.
2. Move the cursor to the PLAY button.
3. Press **Button A, B** or **C** to begin playing the CD.
4. Use the Control Panel to select different Sega CD features.
(For details on the features, see pages 17-22).



PLAYING AUDIO PLUS GRAPHICS DISCS (CD+G)

1. Place a CD+G in the disc tray and close the CD door.
2. Move the cursor to the CD+G button, and press **Button A, B** or **C**. The cursor automatically moves to PLAY.
3. Press **Button A** or **C** to begin playing the disc.

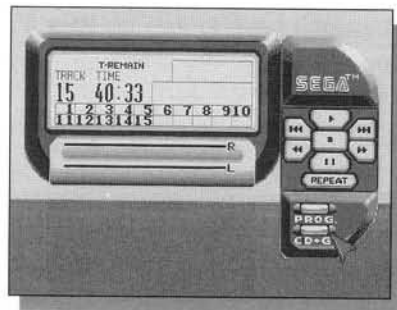

Note: The Sega CD displays dazzling graphics with up to 64 colors from a 512-color palette.

4. Press **Button B** to hide the Control Panel. Use the Quick Buttons (see page 15) to operate the Sega CD while the Control Panel is hidden. Press **Button B** again when you want to restore the Control Panel. (With every other toggle, a status line appears on the CD+G screen.)

Note: Since Button B toggles the Control Panel off and on during CD+G play, it is not used to execute the Control Panel options.

5. To turn off the graphics display while continuing the audio, move the cursor to the CD+G button and press **A** or **C**. The button will no longer be highlighted.
6. When the Control Panel is on screen, use it to select different Sega CD features. (For details on the features, see pages 17-22).

Note: When playing a CD+G, the SEARCH option changes to the CD+G CHANNEL option. See page 18 for more information.

7. When the disc finishes playing, press **Button B** to bring up the Control Panel if it's not already on screen.

PLAYING SEGA CD GAMES (CD-ROMS)

1. Place a Sega CD game in the disc tray and close the CD door.
2. Press **Start** to move the cursor to the CD-ROM button.
3. Press **Button A, B** or **C** to begin the game. (See your game manual for instructions on how to play the game.)

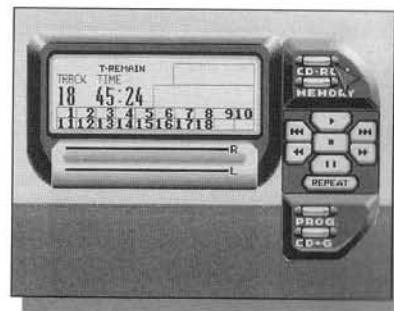

4. Press **Reset** at any time to stop the disc. The screen returns to the Sega CD logo.

You can play cartridge games on your Genesis, even when it's connected to the Sega CD. With the power switch OFF, insert the cartridge into the cartridge slot. When you turn the power switch ON, the Genesis defaults to cartridge play.

Note: For best system performance, it's recommended that you keep the Sega CD's power adapter plugged in while playing Genesis cartridge games.

SAVING YOUR GAMES

The MEMORY button becomes available on the Control Panel when a Sega CD game is in the drive. Use this button to format the Sega CD's internal back-up memory in order to save games. If your Sega CD software has a Save feature (often available in sports games and role-playing games), you can save your current game to the Sega CD's internal memory. Later, you can load the saved game and continue playing from where you left off. (See page 22 for details on using the MEMORY feature).

ENDING A SESSION

1. Move the cursor to the STOP button and press **Button A** or **C**.
2. Open the CD door and remove the disc.
3. Close the door.
4. Turn off the Genesis.

USING THE SEGA CD FEATURES

THE CONTROL PANEL



The Sega CD Control Panel has all the features you need to thoroughly enjoy your compact discs. This section describes the features.

CONTROL PANEL DISPLAY

The display in the upper half of the Control Panel keeps you informed about disc tracks, time and status.

- | | |
|----------------------|--|
| Tracks | Shows all the tracks available on your disc. A box highlights the track that's currently playing. This track number is also shown to the left of the Time display. |
| Volume Levels | Shows the volume variations for both the left and right channels while a disc is playing. |
| Current Track | Shows the number of the track that is currently playing. This number is also highlighted on the Track display above the Volume Levels. |
| Status | Shows the current status of the disc, for example, "Playing," or "Programming." |

- Time** Shows disc time in four different modes:
- Elapsed time for the current track.
 - Total elapsed time since the disc started playing.
 - Time remaining on the current track.
 - Total time remaining on the disc.

CONTROL PANEL BUTTONS

The buttons in the lower half are options you can use to work with your disc.

- Select a button by moving the cursor to it with the **D-Pad**.
- Execute the option by pressing **Button A, B or C**.
- A button highlights when its option is executed. It dims again when another option is executed, or when its function is over, or when the CLEAR button is pressed.

PLAY Plays the audio tracks of a disc.

PAUSE Pauses the current track. Press the PLAY button or the PAUSE button again to resume playing.

STOP Stops the current track.

AUTO SEARCH Takes you forward (right arrow) or back (left arrow) by one track. After selecting a track, use PLAY to play it. AUTO SEARCH can be used while PLAY, PAUSE or STOP is highlighted.

SEARCH Cues forward (right arrow) or cues back (left arrow) through the current track while you hold down **Button A, B, or C**.

CD+G CHANNEL When the Sega CD is displaying CD+G graphics, the SEARCH option changes to CD+G CHANNEL. Hold down **Buttons A, B, or C** on the up or down arrows to change the CD+G channel. Some CD+Gs have multiple graphics channels; others may have various language channels for the same graphics.

Note: Use CD+G CHANNEL **only** with discs that contain graphics. Do not use it with any discs that do not have graphics tracks.

PROG. Opens the Program menu, which has options for setting track order, displaying time modes, and many other features. PROG. can be used while PLAY, PAUSE or STOP is highlighted. For details, see pages 19-22.

MEMORY Opens the Memory menu, which has features for formatting the Sega CD's internal memory, saving and erasing games. MEMORY is available when a Sega CD game disc is in the drive. (For details on using MEMORY, see page 22).

CD-ROM Starts a Sega CD game. This option is available only when a Sega CD game disc is in the drive.

CD+G

Starts a graphics display. The CD+G option should be selected only when a CD+G disc is in the drive. When a CD+G disc is playing, the SEARCH option changes to CD+G CHANNEL option.

Note: Use the CD+G button **only** with discs that contain graphics.

THE PROGRAM MENU

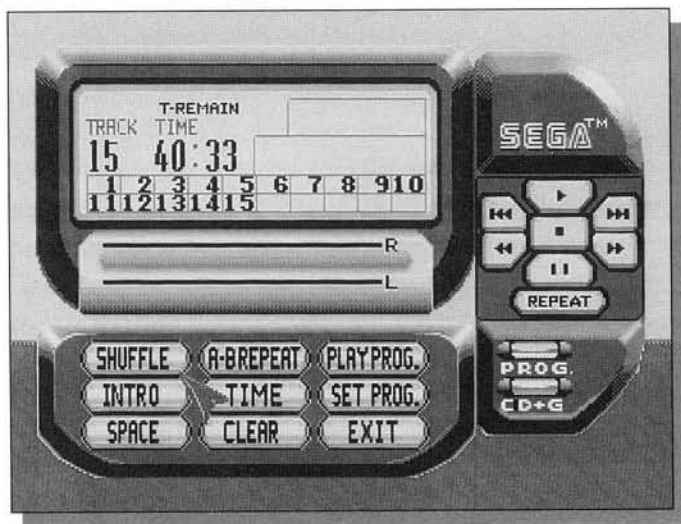

This section describes the Program menu features.

- Select an option by moving the cursor to it with the **D-Pad**.
- Execute the option by pressing **Button A, B or C**.
- An option highlights when it is executed. It dims again when its function is over or the **CLEAR** button is pressed.

REPEAT

Pressed once, REPEAT ALL appears and the current program repeats until the option is turned off. Pressed twice, REPEAT ONE appears and the current track repeats until the option is turned off.

A-B REPEAT

Repeats a section of a track. When you press **Button A, B or C**, the option turns green, setting mark A. The second time you press the button, the option turns yellow, setting mark B. While the option is yellow, the track will repeat from A to B. This option can be set while any other option is highlighted. The option continues until you **CLEAR** it, **STOP**, or select the option again and press **Button A, B or C**.

Note: The A-B REPEAT option is not usable when you're playing a CD+G.

CLEAR

Clears the REPEAT, A-B REPEAT, SHUFFLE, INTRO, SPACE and PLAY PROG options and continues normal playing from the current track.

SHUFFLE

Mixes the tracks in a random order. The option turns yellow, and the shuffled order of tracks appears on the Control Panel display. This option can be set while any other option is highlighted. The shuffled order remains until you select the option again and press **Button A, B or C**.

INTRO

Plays a set number of seconds from the beginning of each track, starting with the current track and continuing through all following tracks. When you press **Button A, B or C**, the option turns yellow and the cursor moves to a number that appears on the Control Panel display. The number starts at 10. Press the **D-Pad** up or down to increase the number (up to 59 seconds) or decrease it (down to 1 second). Press **Button A, B or C** again to set that number of seconds. To play INTRO, exit the program, choose PLAY and press **Button A, B or C**. INTRO can be set while any other option is highlighted. INTRO play continues until it's played through to the end of the disc, or until you CLEAR it or select the option again and press **Button A, B or C**.



SPACE

Pauses for a set number of seconds before the beginning of each track. When you press **Button A, B or C**, the option turns yellow and the cursor moves to a number that appears on the Control Panel display. The number starts at 10. Press the **D-Pad** up or down to increase the number (up to 59 seconds) or decrease it (down to 1 second). Press **Button A, B or C** again to set that amount of time as a pause between tracks. During pause time, the PAUSE button on the Control Panel also turns yellow. SPACE can be set while any other option is highlighted. The pauses continue until you CLEAR them, or select the SPACE option again and press **Button A, B or C**.

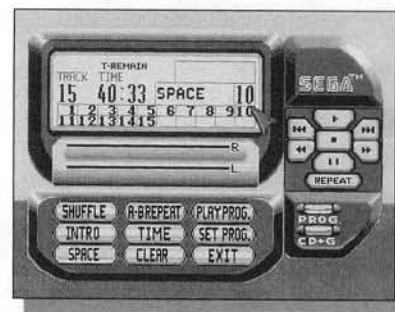

PLAY PROG.

Plays the program you set with the SET PROG. option (described on the next page). PLAY PROG. continues until you STOP it, CLEAR it, or select the option again and press **Button A, B, or C**. You cannot use the SET PROG. option when the PLAY PROG. option is highlighted.

SET PROG.

Lets you set the order of tracks that will be played. When you press **Button A, B** or **C**, the Set Program menu appears.

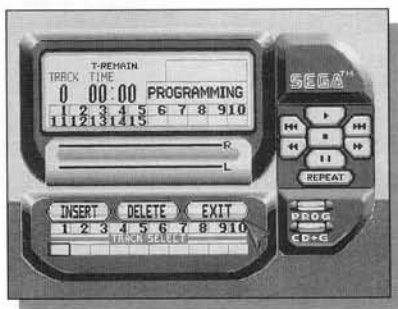

Here's how to use the menu:

To set the track order:

When the menu first appears, its INSERT option is highlighted. Move the cursor in the upper Track Select line to the number of the track you want, and press **Button A, B** or **C**. That track number appears in the box on the lower Tracks Set line, and the box moves to the right. Continue selecting tracks in this way. You can repeat tracks, and set up to 99 tracks in the lower Tracks Set line.

To insert tracks in the Tracks Set line:

With the INSERT option highlighted, move the cursor to the box on the lower Tracks Set line. Then press the **D-Pad** left or right to move the box over any track number. Next, press the **D-Pad** up to move the cursor to the upper Track Select line, and press left or right to point to the number of the track you want. Press **Button A, B** or **C** to place that number inside the box in the lower Tracks Set line.

SET PROG. (continued)

To delete tracks from the Tracks Set line:

Move the cursor to the DELETE option and press **Button A, B** or **C** to highlight it. Then move the cursor to a track number in the lower Tracks Set line. Press **Button A, B** or **C** again to delete the track from your program.

To close the Set Program menu:

Move the cursor to the EXIT option and press **Button A, B** or **C**. You'll see the Program menu again, with the cursor pointing to the PLAY PROG. option.

Use the PLAY PROG. option to play the tracks in the order you set them. SET PROG. can be used when any other option except PLAY PROG. is highlighted. The program you set is not affected when you CLEAR or STOP. It remains intact until you change it or open the CD door.

TIME

Displays four different time modes on the Control Panel in this order:

- Elapsed – Time that has passed since the current track started playing.
- T-Elapsed – Total time that has passed since the disc started playing.
- Remain – Time remaining in the current track.
- T-Remain – Total time remaining on the disc.

When the cursor is on the option, the TIME mode changes each time you press **Button A, B** or **C**.

EXIT

Closes the Program menu. (You can also press **Start** to close the menu.) You must close the menu in order to use the Control Panel buttons. Closing the menu does not affect the Program menu settings.

THE MEMORY MENU

Some games, such as RPGs (role-playing games) let you save your current game so you can continue it later. On CD software, game data cannot be saved on the compact disc, so the Sega CD has internal back up memory for this purpose.

The MEMORY feature is available when a Sega CD game is in the drive. Use this feature to format the Sega CD's internal memory and to save and erase games.

1. Move the cursor to **MEMORY** and press **Button A, B** or **C**. The Data Storage Information screen appears. This screen gives you information about the SEGA CD's internal memory.

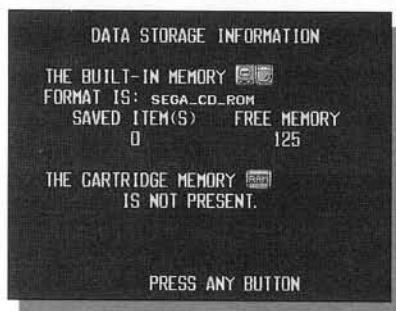

2. Press **Start** or **Button A, B** or **C** to go on to the MEMORY menu.

3. Press the **D-Pad** up or down to choose an option. Then press **Start** or **Button A, B** or **C**.

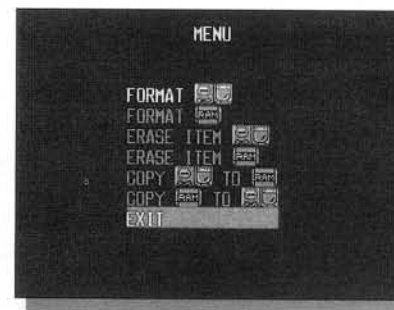

4. Follow the instructions on screen to complete the operation.

Note: The cartridge memory shown on screen refers to an additional memory-saving device that will be available later.

Important Information about Sega CD Memory

- Memory must be formatted before you can save games to it. Use the first **FORMAT** option in the Memory menu to format the Sega CD's internal memory.
- The Sega CD can save up to 64 Kbits of memory. When the memory is full, make room by deleting items.
- The Sega CD will retain saved games for up to one month without being powered on. After that time, saved data may disappear. If that happens, you'll need to reformat the internal memory. Reformatting will erase any remaining saved games. After reformatting, leave the Sega CD powered on for at least six hours before using its internal memory again.

MAINTAINING YOUR SEGA CD

The Sega CD's Location

- Set up the Sega CD in a well-ventilated area. Position it on a stable, flat surface that is not prone to vibration.
- Keep your Sega CD out of direct sunlight and away from extreme hot or cold temperatures, such as near a heater or in an uninsulated garage.
- Don't let the Sega CD get wet. Avoid using it in humid areas. If condensation forms on the console, wipe it dry, and let the system rest for at least an hour before using it.

The Console

- Insert only 8cm or 12cm discs into the disc tray. Do not use discs designed for other game units.
- Always use the **Open** button to open and close the CD door. Attempting to operate the CD door manually may cause it to malfunction.
- Do not open the CD door when a Sega CD game is playing.
- Always remove a disc before moving the console.
- Do not take the console apart or alter it in any way. Never touch the connectors, or insert foreign objects into the connector terminal.
- Don't drop the console or pick it up by any connecting cable. Don't twist or pull the cables forcefully. Doing so may damage their connections.
- Don't spill liquids onto the console or into the disc tray.
- Clean the console with a soft, slightly damp cloth. Never use strong cleaning solutions or abrasives that could damage the components.

Power Supply

- Use only the AC adapter supplied with your Sega CD to connect the Sega CD to power.
- Always turn the Genesis power switch OFF before connecting or disconnecting the Sega CD.

TROUBLESHOOTING

Problem

LED doesn't come on.

No picture on screen.

Sega CD logo doesn't appear.

TV color doesn't look right.

No sound.

Check the Following Items

- Are AC adapters connected to both the Sega CD and the Genesis?
- Are both adapters plugged into power outlets? Are the power outlets in working order?
- Is the Sega CD connected correctly to the Genesis? Are all cable connections secure? (See pages 4-7.)
- Is the TV or monitor turned on?
- Is the channel switch setting (3 or 4) on the back of the Genesis the same as the TV channel being used?
- Is the Genesis power switch turned on?
- Is the TV brightness control adjusted properly?
- Is a game cartridge **firmly** inserted in the Genesis cartridge slot?
- Are the TV color controls adjusted properly. (The Sega CD can display up to 512 colors, with up to 64 colors at one time.)
- If you've connected the system to stereo sound, are the cable connections correct? (See pages 8-11.)
- Is the sound mixing cable properly connected between the Sega CD and the original Genesis model?
- Are the volume controls adjusted properly on your TV or stereo system and on the original Genesis model?

If a problem continues, follow the instructions in this manual to carefully reconnect your system. If a problem persists, please call the Sega Consumer Service Department at 1-800-USA-SEGA.

SEGA-CD HARDWARE INFORMATION

Physical Characteristics

Model name:	MK-4101
Power usage:	Custom AC adapter (DC9V 1.2A)
Elec. consumption:	Approx. 18W max
Elec. current consumption:	600mA (during CD revolution)
Usage environment:	Temperature: 0°-40° C Humidity : 10%-80% RH
Exterior measurements:	Width: 396mm Depth: 220mm Height: 84mm

Specifications

CPU:	68000 (12.5MHz)
Memory:	RAM: 6 Mbit (program, picture data, sound data) 512 Kbit (PCM waveform memory) 128 Kbit (CD-ROM data cache memory) 64 Kbit (backup memory)
	Boot ROM: 1 Mbit CD game BIOS CD player software CD+G compatible
Sound circuitry:	PCM sound source: Stereo 8 channels Sampling wavelength 32KHz max
	D/A converter: 16 bit D/A converter 8x internal over-sampling digital filter PCM and CD sound mixing Mixing with mixing terminal possible

Specifications (cont.)

Audio characteristics:	Wavelength characteristics: 20Hz-20KHz Signal v. noise ratio (S/N): Over 90dB (1KHz) (Line Out) Timing range: Over 90dB
Battery back-up secondary duration:	Approx. 1 month
CD drive unit:	CD diameter: 12cm and 8cm Rotational direction: Counter-clockwise (against surface read) Access time: Average 0.8 sec.
Audio output:	Line Out: RCA pin jack x2 (L/R)
Audio input:	Mixing: Stereo jack mixing

Note: Characteristics and specifications may be changed without notice.

LIMITED WARRANTY

Sega of America, Inc., warrants that the Sega CD and all component parts shall be free from defects in material and workmanship for a period of 90 days from the date of purchase. If a defect covered by this limited warranty occurs during this 90-day warranty period, Sega will repair or replace the defective cartridge or component part, at its option, free of charge.

This limited warranty does not apply if the defects have been caused by negligence, accident, unreasonable use, modification, tampering, or any other causes not related to defective materials or workmanship. Additionally, this warranty shall not be valid if the serial number of the Sega CD has been altered, defaced or removed in any way.

Please retain your dated sales receipt to easily establish the date of purchase for in-warranty repairs. To receive warranty service, call the Sega Consumer Service Department at: **1-800-USA-SEGA**

To receive Canadian warranty service, call the Sega of Canada Consumer Service Department at: **1-800-872-7342**

PLEASE CALL FIRST FOR REPAIR INFORMATION. The cost of returning the system to Sega's Service Center shall be paid by the purchaser.

DO NOT RETURN YOUR SEGA CD TO THE RETAIL SELLER.

REPAIRS AFTER EXPIRATION OF LIMITED WARRANTY

If your Sega CD requires repairs after termination of the 90-day limited warranty period, you may contact the Sega Consumer Service Department at the number listed above. If the technician is unable to solve the problem by phone, he or she will advise you of the estimated cost of repair. If you elect to have the repair done, you will need to return the defective merchandise, freight prepaid and insured against loss or damage, to Sega's Service Center with an enclosed check or money order payable to Sega of America, Inc., for the amount of the cost estimate provided to you by the technician. If, after inspection, it is determined that your system cannot be repaired, it will be returned to you and your payment will be refunded.

LIMITATIONS ON WARRANTY

Any applicable implied warranties, including warranties of merchantability and fitness for a particular purpose, are hereby limited to 90 days from the date of purchase and are subject to the conditions set forth herein. In no event shall Sega of America, Inc., be liable for consequential or incidental damages resulting from the breach of any express or implied warranties.

The provisions of this limited warranty are valid in the United States and Canada only. Some states do not allow limitations on how long an implied warranty lasts, or exclusion of consequential or incidental damages, so the above limitation or exclusion may not apply to you. This limited warranty provides you with specific legal rights. You may have other rights which vary from state to state.

WARNING

This equipment has been tested and found to comply with the limits for a Class B digital device, pursuant to Part 15 of the FCC Rules. These limits are designed to provide reasonable protection against harmful interference in a residential installation. This equipment generates, uses and can radiate radio frequency energy and, if not installed and used in accordance with the instructions, may cause interference to radio communications. However, there is no guarantee that interference will not occur in a particular installation. If this equipment does cause harmful interference to radio or television reception, which can be determined by turning the equipment off and on, the user is encouraged to try to correct the interference by one or more of the following measures:

- Reorient or relocate the receiving antenna.
- Increase the separation between the Sega CD and receiver.
- Connect the Sega CD into an outlet on a circuit different from that to which the receiver is connected.
- Consult the dealer or an experienced radio/television technician for help.

CAUTION!

Please note that changes or modifications not expressly approved by the party responsible for FCC compliance may void the user's authority to operate the equipment. Please check with the manufacturer prior to effecting any changes or modifications to the Sega CD system. Please also note that the Sega CD system connecting cable which is attached is made of shielded wire. If cable other than that supplied with this Sega CD system is used, there is the possibility of violating FCC emission limits. Such change or modification of the Sega CD system is prohibited as per the previous warning. Therefore, use the attached shielded cable when setting up and using the Sega CD system.

If necessary, consult the dealer or an experienced radio/television technician for additional suggestions. You may find the following booklet prepared by the Federal Communications Commission helpful: *How to Identify and Resolve Radio-TV Interference Problems*. This booklet is available from the U.S. Government Printing Office, Washington, D.C., 20402, Stock No. 004-000-00345-4.

NOTES

NOTES

Before you connect your Sega CD™...

See Page 4 of your User's Guide. This page shows how to prepare your Sega™ Genesis™ by (1) unplugging the AC adapter, and (2) removing the expansion slot panel and the red plastic cover from the expansion slot connector.

Look carefully at the 'piano' contacts on the connector (A). Over time, some tarnish or corrosion may have accumulated. As a result, your Sega CD™ may not make a good electrical contact with your Sega Genesis.

If the contacts appear to be tarnished, carefully clean **both sides** with a soft, non-abrasive art eraser. You may also use a pencil eraser, rubbing gently to prevent damage to the contacts. If you continue to experience a problem, please call us at 1-800-USA-SEGA (1-800-872-7342) for assistance.

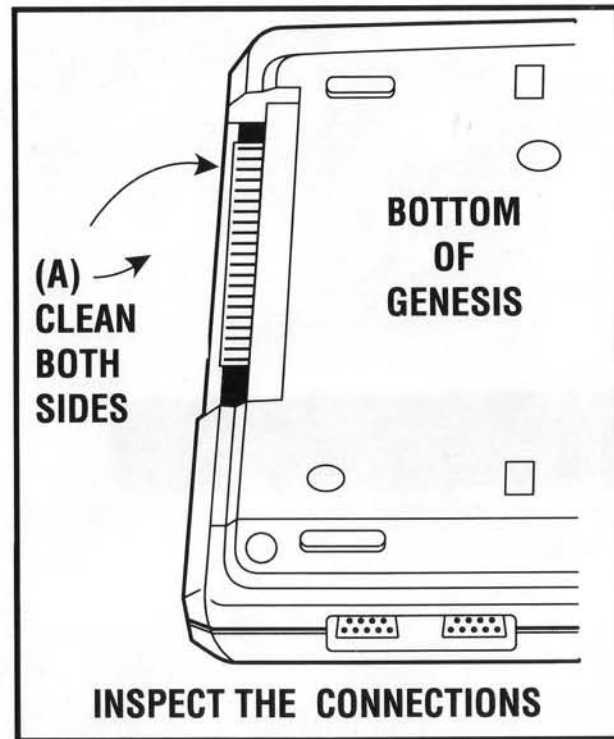

Happy Gaming!

This product has been reconditioned to its original specifications for electrical performance. It has been 100% tested by Sega of America, Inc. The electrical performance of this product is warranted under the terms of our written limited warranty. This warranty does not apply to the cosmetic appearance of the product.

Sega, Genesis, Sega CD, and Welcome to the Next Level are trademarks of

SEGA.® 1993 SEGA, 3335 Arden Road, Hayward, CA 94545

All rights reserved. Printed in U.S.A. (672-1257-01)

For use in North America with the NTSC Genesis.

SEGA CD™
CD ROM ENTERTAINMENT SYSTEM FOR GENESIS™